

TCB-1
Tactical Communications Bridge Radio Interface

Software Version 2.007
Copyright 2005, All Rights Reserved



Link Communications, Inc.
1035 Cerise Rd
Billings, MT 59101-7378
(406) 245-5002 Voice
(406) 245-4889 Fax

<http://www.link-comm.com>

<http://www.tcb1.net>

This Page Intentionally Left Blank

Table of Content

Limited Warranty	1
Return Policy	3
TCB-1 Radio Connection Table	5
Male DB-9	5
2 pin Phoenix Power Connector	5
RJ-45 Connector	6
Rear Panel Connections	7
Introduction:	8
Requirements for the TCB-1:	8
Audio:	8
Power:	8
Brief Description:	8
Receiver Level:	9
Transmit Level:	9
Recorder Level:	9
TCB-1 Menu and Functional Description:	9
How to read and navigate thru the TCB-1 menu system:	11
Menu Levels	11
Level 0	11
Level 1	12
How do I get in to Level 1?	12
Is this level password protected?	12
Select a radio type	12
Exiting Level 1	12
Level 2	13
How do I get in to Level 2?	13
Is this level password protected?	13
Editing a radio profile	13
Exiting Level 2	14
Level 3	14
How do I get in to Level 3?	14
Is this level password protected?	14
Selecting five menu editing menus	14
The Adjuster:	15
Special Case Knob function [Reset TCB-1 to factory settings]	15
Special Case Knob function [Enter set-up mode from the operate mode]	15
Special Case Knob function [Exit set-up mode and save changes]	15
Level 1 Example	16
System Flowchart 1	18

System Flowchart 2	19
Menu Description	20
Runtime display prompt	20
Set Radio 1 Type?	20
Set Radio 2 Type?	20
Edit Radio 1 (Menu 4)	20
Edit Radio 2 (Menu 5)	20
VOX Sensitivity Adjustment:	23
Under Radio1 Timers .. Radio 1 VOX Hang-Timer:	25
Under Radio1 Timers .. Radio 1 Rx Activity Delay Timer:	25
Port 1 Setup (Menu 6)	26
Port 2 Setup (Menu 7)	26
Port Connections	
(Mode A and Mode B Settings	29
System Setup	30
Microphone and Speaker Setup	31
Radio Port Configuration Settings	32
Switch Definitions	32
TCB's Pre-fabricated radio cables (Factory Default Setting)	35
TCB's Balanced In/Out w/E&M contact closure Signaling	36
E&M Type 2/3, 4 Wire Interface	37
Un-Balanced Audio In/Out with COR/CTCSS signaling	38
RS-232 Serial Port	41

Limited Warranty

COVERAGE:

Link Communications, Inc. warrants that its products will be free from defects in materials and workmanship for a period of two years from the date of shipment. During this time, Link Communications, Inc. will cover parts, labor and return shipping. If failure is caused by instances other than manufacturing defects, Link Communications, Inc. will repair the product and bill the customer for parts and labor. Contact Link Communications, Inc. for more information.

What Link Communications, Inc. will not cover:

1. Too much voltage to the controller. The TCB-1 operates at +11V to +18V, negative ground.
2. Damage to the controller by lightning, accident, or incorrect power hook-up.
3. Incorrect unit installation.
4. Damage caused by shipment (damage claims are handled by the carrier).
6. Repairs by other than Link Communications, Inc.

HOW TO GET SERVICE

Please contact Link Communications, Inc. for servicing information and authorization. Technical support can be handled two ways. The preferred method is via E-mail. Send e-mail support inquiries to support@link-comm.com. Telephone support is handled on the following number (406) 245-5002. Please do not use our '800 sales line for technical support. We try to keep this number open for sales calls.

SOFTWARE

Link Communications, Inc. holds the copyright on the TCB-1 software and hardware. Changes to the software and/or copying of the software without the written consent of Link Communications, Inc is strictly prohibited.

SOFTWARE UPDATES

Link Communications, Inc. will provide FREE Software updates for 6 months from the date of purchase. The cost for later software updates will be determined at the release of the update. Manual inserts and shipping are additional.

This Page Intentionally Left Blank

Return Policy

These policies supersede policies appearing on all other Link Communications, Inc. literature and are in effect for purchases made after March 1, 1989.

- **Please keep all packing material and documentation in the event that your equipment has to be serviced or returned.**
- Before returning any product, you must obtain a Return Authorization (RMA) number. You can obtain this by calling (406) 245-5002.
- **No returns, of any type, will be accepted without an RMA number. Please have the following information on hand when calling for an RMA number:** customer name, invoice number, serial number, and the nature of the problem. All can be found on your invoice.
- All product to be returned must **be returned within 30 days** from the invoice date, 100% complete, and must include manuals, parts bags, and other accessories provided by the manufacturer.
- All defective products will be accepted directly by Link Communications, Inc. for credit, exchange, replacement, or repair at Link Communications, Inc.'s discretion. **After 30 days from invoice date, the manufacturer's warranty applies.**
- All non-defective returns for credit, exchange, or refund are subject to a restocking fee on the schedule listed below. No returns will be accepted beyond the 30 day period. Shipping costs are not refundable.
 - 0 to 10 days 5% restocking
 - 11 to 20 days 10% restocking
 - 21 to 30 days 15% restocking
- **Link Communications, Inc. reserves the right to authorize product returns beyond 30 days from date of invoice. If the product is accepted after 30 days, credit will be issued toward FUTURE PURCHASE ONLY.**

If you have any questions — JUST ASK.

All of us have tried to make sure that this order has been shipped correctly. If we have made an error - we want to make it right. If you have a question or problem with this order, just write or call, and our staff will personally handle your situation.

Link Communications, Inc. is a Montana Corporation

FEIN 81-0490597

This Page Intentionally Left Blank

TCB-1 Radio Connection Table

Connector Type: Male DB-9

Pin 1	-	Ground
Pin 2	-	CTCSS / DCS Detect Input (Configurable between active high and low)
Pin 3	-	PTT Output, Active Low
Pin 4	-	TCB Audio Output, Microphone Input
Pin 5	-	TCB Audio Input, Speaker or squelched audio input
Pin 6	-	Ground
Pin 7	-	COR Detect Input (Configurable between active high and low)
Pin 8	-	Ground
Pin 9	-	Ground

The multiple grounds are available for signal input. The user does not need to tie these ground signals together. They are provided for the user interface.

The CTCSS / DCS and COR (receiver squelch detection) input should not go below 0V. Damage can result to the TCB if negative voltage is applied.

Audio input level should not exceed 10V p-p. Distortion will occur if the audio level exceeds this specified level. Audio input load is specified at 100K Ω . Audio is AC coupled within the TCB. No external capacitor is required.

Audio output level is specified from 0V to 9V p-p. Audio output load is specified at 600 Ω . Audio output is generally AC coupled with a DC to ground load of 50K Ω .

PTT output is specified to drive a 100mA load maximum. Greater load driving requires external current protection. PTT (Push-To-Talk) is low (ground potential) in transmit and open in receive.

Pre-Built radio cables for most radios are available from Link Communications at a nominal price. If your cable is not listed, contact us for a cost savings solutions on custom cables.

Power Requirements:

Connector Type: 2 pin Phoenix Power Connector

Viewed from the rear of the TCB-1. Power input must be +11V ..+18V DC. Current requirements, 1 Amp DC power cube (Included).

TCB-1, with LCD backlight on draws ~3500mA current at +12V DC input.

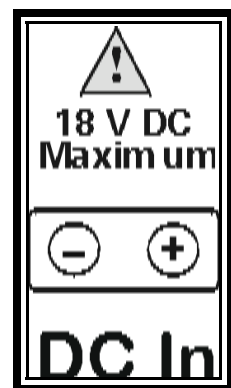

RJ-45 Connector pin-out:

Located on the rear of the TCB-1 are two RJ-45, 8 conductor connectors. These connectors provide balanced audio input, balanced audio output and a dry-contact PTT output signal. The signals on these connectors is completely ground isolated from the TCB-1. Applications requiring balanced audio input (Speaker +/- signals), ground loop elimination or intrinsic installations would utilize this connector. The connector will accept standard RJ-45 connectors used in data communications (Cat 5 network cables...). The RJ-45 connector is a self latching connector and a smaller, less weight than the DB-9 connectors. All pre-manufactured cables available from Link Communications utilize this connector.

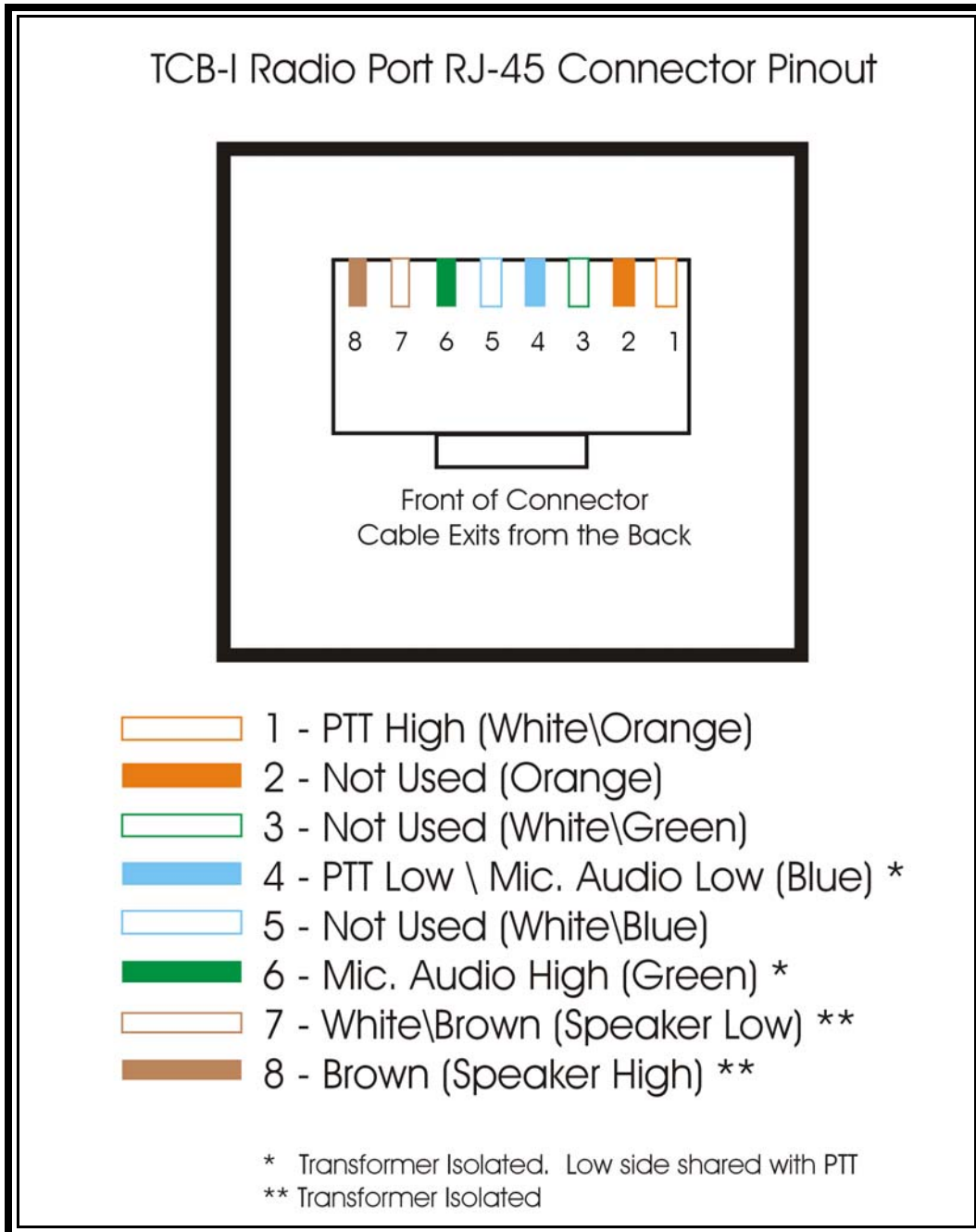

Rear Panel Connections

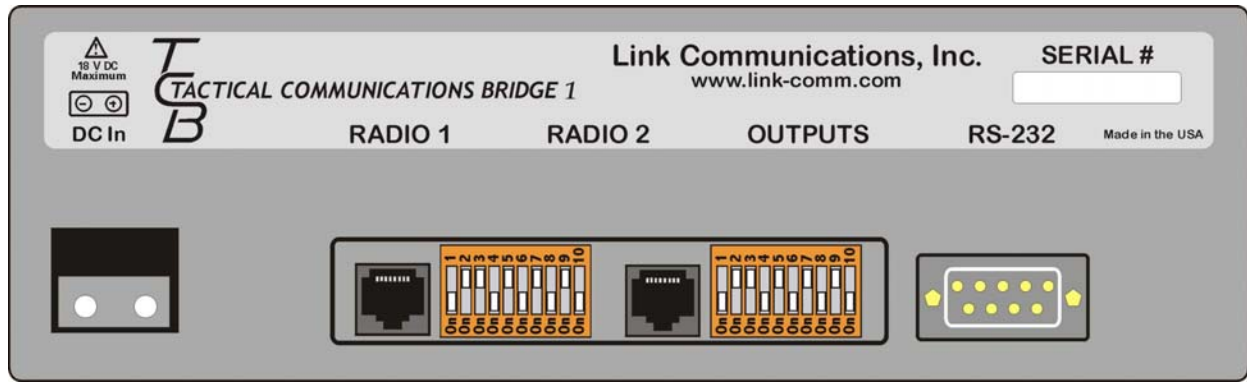

On the rear of the TCB-1 are the different connections needed for radio, outputs and computer communication.

Radio 1 and Radio 2:

These connections are what you use to interface your radios to the TCB-1. See the above table for the pin-outs for the radio DB-9's. The RJ-45 connections are designed for our pre-fabricated radio cables Use only Link Communications, Inc cables with these plug-in's.

Outputs:

The output connector is intended to be used for channel control on a variety of radios that support remote channel control. The outputs are high current (500mA), open collector outputs. User access to these lines are not currently supported in software.

RS-232 Port:

The RS-232 port is used to upload software updates for the TCB-1. You can also download the data flash memory contents. The data flash stores all the unique setup information for the TCB-1 and can be uploaded to other TCB-1's for cloning purposes. It is also a good idea to download the data flash for a backup incase of problems. For more information on the data flash download and upload, refer to the Data Flash Procedure Applications Note available from the TCB's web site.

The site address is: <http://www.link-comm.com/security.html>

Introduction:

Congratulations on your purchase of the TCB-1. This manual will outline the interfaces operation, configuration and programming features. If the manual does not answer all of your questions, either e-mail or call to speak with one of the TCB's engineers. E-mail requests can be sent to support@link-comm.com.

Requirements for the TCB-1:

There are a couple of requirements for the correct operation of the TCB-1.

Audio:

The audio input to the TCB-1 needs to be squelched audio if using the VOX as the access mode.

Power:

The TCB-1 operates from +11 ~ +18V DC @400mA maximum current

Brief Description:

The TCB-1 is a 2 port radio interface controller.

Each of the ports can have the following operating modes

1. Conventional
2. Trunked
3. Full-Duplex Conventional
4. Conventional Repeater
5. Simplex (voice store and forward) Repeater

Each port can be connected to the other ports as follows

6. Port 1 → Port 2 (Port 1 causes a transmit on Port 2)
7. Port 1 ← Port 2 (Port 2 causes a transmit on Port 1)
8. Port 1 ↔ Port 2 (Port 1 and Port 2 are connected, both receive and transmit)
9. Port 1 - - Port 2 (Port 1 is disconnected from Port 2)

Each port can have the following access modes

10. VOX (Audio from the receiver is detected for an active/inactive indication)
11. COR (An external logic input on the COR line is required for activity)
12. CTCSS (An external logic input on the CTCSS line is required for activity)
13. COR and CTCSS (Activity on both COR and CTCSS inputs required)
14. ON (Forces an active always for a port. Used for testing only)
15. OFF (Forces an inactive always for a port. Used for testing only)

VOX is the default state for all radio ports.

When in COR and/or CTCSS mode, the following settings are available

16. COR pull up and/or down resistor
17. CTCSS pull up and/or down resistor
18. COR polarity for active state

19. CTCSS polarity for active state
20. COR active threshold
21. CTCSS active threshold

Receiver Level:

Once the system access mode is assigned, receiver and transmitter audio levels are set. The TCB's receiver audio is converted from analog to digital with 16 bits of resolution for a 96dB dynamic range. Within the receiver audio chain, the user can control whether automatic gain control (AGC) is used. AGC takes the guesswork out of setting the receiver audio input level. The AGC is a digital signal processor (DSP) controlled variable that automatically adjusts the incoming receiver audio level. The DSP either adjusts gain to the audio level (the incoming audio is too low) or adjusts attenuation (the incoming audio is too high) to make the connected receivers audio sound the best. The AGC defaults to 'ON' for all ports.

If the AGC is disabled, the user must set the receiver's audio level. This adjustment ranges from 0 to 1050. There is a "Detected %" meter that indicates the detected audio's average level. Clipping will occur when the detection hits 100%. Generally the audio is centered around 70% for the best, non clipping, digital conversion of the audio.

The receiver's audio setting is stored in the radio's personality settings (discussed later).

Transmit Level:

The TCB's transmit audio is converted from digital to analog with 16 bits of resolution for a 96dB dynamic range. The transmit level can be adjusted from 0 to 255. Level 0..255 is at a lower maximum level and level 256..511 is a higher (10x) level. The two levels are required for handheld (0..255) vs. mobile radio (256..511) microphone audio. This level should be adjusted using a communications service monitor (General Dynamics R-2590a or similar). If this level is too high, your transmitted audio could overdrive the radio you are interfacing to.

The transmitter's audio setting is stored in the radio's personality settings.

Recorder Level:

The TCB-1 supports recorded store and forward audio in its Simplex Repeater operational mode. When configured in this mode, your receiver's audio is recorded for up to two minutes, then played back over the transmitter. This allows a repeater without the duplex radios, duplexers etc. The recorder level is the level which the store and forward audio is played over the transmitter. This level defaults to 220. The transmit level is the master transmit level, so this level should not need to be adjusted.

This covers the basics of the TCB's general operational mode and audio handling.

TCB-1 Menu and Functional Description:

Operational Modes

The TCB-1 contains two operational modes, referenced as Mode A and Mode B operation. The user can switch between these two modes using either the front panel Mode switch, or by

remotely functioning the TCB-1 using a DTMF string. Either way, you can easily configure how the TCB operates.

Mode A

Mode 'A' is the default mode. In this mode, the TCB's radio ports are connected together in the '<->' condition. In this mode, when Port 1's receiver is detected as active, a PTT is applied to Port 2's transmitter. When Port 2's receiver goes active, a PTT is applied to Port 1's transmitter. This is the factory default condition for Mode 'A'.

Mode B

Mode 'B' is the second default mode. In this mode, the TCB's radio ports are disconnected in the '- -' condition. In this mode, Port 1's operation is completely isolated from Port 2. Any operation on either port is isolated from the other ports. This is the factory default condition for Mode 'B'.

When viewing the LCD display, Mode A and Mode B only affect the connection information contained on the top line.

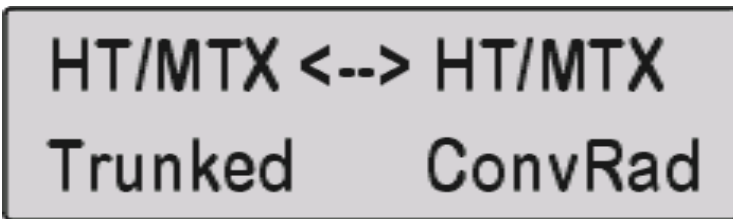

HT/MTX <--> HT/MTX
Trunked ConvRad

LCD Display: Mode A

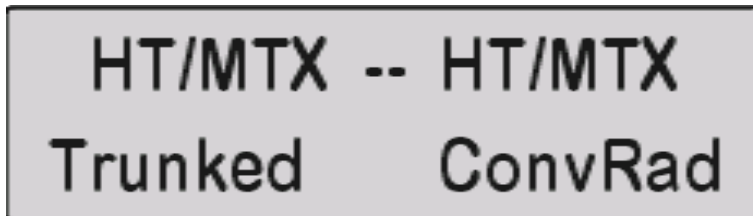

HT/MTX - - HT/MTX
Trunked ConvRad

LCD Display: Mode B

How to read and navigate thru the TCB-1 menu system:

The TCB menu system is accessed from the adjuster knob. Descriptions of each menu function is be referenced from the menu number. This number is located to the right of the menu box located on the TCB-1 Menu Flow diagram.

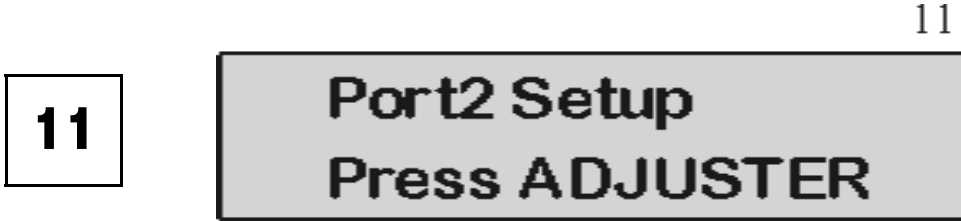

For example, the above description is for Port 2 Setup. The '11' indicates what menu number that has been assigned to this description. In the manual, you would search for the '11' and the description will follow. For navigation thru the flow menu, simply find the menu number and you answer is very near.

You can always get back to the operation state by holding down the adjuster until it says to release. Your changes will be saved, and the TCB-1 is now under the new settings.

Menu Levels:

The TCB-1's menu system is arranged into four menu levels. These levels allow access to all settings of the TCB-1. Advanced settings addresses the advanced operational features of the TCB-1 and should only be accessed by a knowledgeable persons.

Level 0

Level 0 is the run-time level. This level is displayed during normal operation.

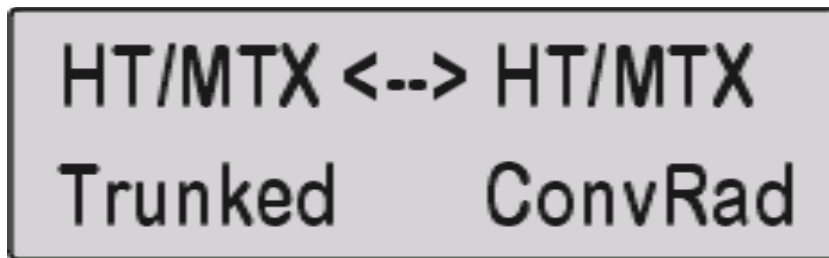

After exiting any of the programming menus or after power-up, the level 0 screen is used. Level 0 display should be considered as the home display. When you see this display, the TCB-1 is in the operating menu, not the configuration menu.

Level 1

Level 1 is referred to as the Selection level. This level allows the user to assign to a radio port, a specific radio. The user selects from the list of radios and assigns it to a port.

How do I get in to Level 1?

Access to Level 1 is from the adjuster knob. From Level 0, the runtime level, the user should press and hold the adjuster until the LCD display shows “Release Adjuster to Select Radios”. When this message appears, release the knob.

Is this level password protected?

When you release the adjuster knob, if the display prompts you for a 3 digit password, you must enter the password in order to access Level 1. If no password is entered within 30 seconds, the display will return to level 0.

The password defaults off. You can change and enable the password under the system menu available from Level 3.

Select a radio type

Once you have entered Level 1, you can select a radio type for both radio ports. The available radios are selected from the Radio profile list. If you needed radio is not listed, you will need to develop a radio profile. Level 2 is the radio profile development/editing level.

If you are going to develop a new profile, it helps to start with one that is close. Selecting either Handheld or Mobile is a good profile to begin with. You will need to exit Level 1 back to Level 0 before you can begin developing a profile at Level 2.

Exiting Level 1

Once you have selected the radio type for either/or both radio ports, you will need to exit. Exiting is accomplished by pressing and holding the adjuster knob until requested to release it. If no changes were made, the exiting process is instant. If changes were made, the TCB-1 will write the changes to the internal Flash permanent memory. This process takes about 5 seconds when changes are written.

Level 2

Level 2 is referred to as the Radio profile editor level. This level allows the user to edit features and settings contained within a radio profile. Once the changes are made to the profile, it is stored in one of the 15 user profile positions.

How do I get in to Level 2?

Access to Level 2 is from the adjuster knob. From Level 0, the runtime level, the user should press and hold the adjuster until the LCD display shows “Release Adjuster to edit Profiles”. When this message appears, release the knob.

Is this level password protected?

When you release the adjuster knob, if the display prompts you for a 3 digit password then only the basic password requirement is enabled. In this case, you must enter the three digit password in order to access Level 2. If the display prompts you for a 6 digit password, then the advanced password requirement is enabled. In this case, you must enter the 6 digit password in order to have access to Level 2.

In general, the TCB-1 will require the most difficult password if both the basic and advanced password systems are enabled. If no password is entered within 30 seconds, the display will return to level 0. The password defaults off. You can change and enable the password under the system menu available from Level 3.

Editing a radio profile

Once you have entered Level 2, you can select to edit Radio 1 or Radio 2's profile. The radio profile contains all the information used when defining a radio type (Name, operating mode, RX level...). Once you have made the needed adjustments and changes to the profile, you are then required to store the changes into one of the 15 user profile positions.

- Edit Programmable Radio Personality
 - Radio Name
 - Radio Operating mode
(Conventional, Trunked, Duplex Radio\Repeater, Simplex Repeater)
 - Radio Access mode (VOX, COR, COR & CTCSS, On, Off)
 - Vox Sensitivity (0 = Most Sensitive, 9 = Least Sensitive)
 - Radio COR and CTCSS parameters
 - Radio Receiver Automatic Gain Control (AGC) (On/Off)
 - Radio Receiver Level (Not important when Radio Receiver AGC is On)
 - Radio Transmit Level
 - Radio Timers
 - VOX hang-time (Defaults to 0.750 seconds)
 - RX activity delay time (Defaults to 0.250 seconds)
 - Trunk Fail Tone (Generates a low tone when a trunk access time occurred)
 - Save Radio personality changes to database (15 user slots available)

Once you have made changes to any of the radio profile settings, you are required to store the changes into a user slot. This ensures that changes made will be stored in the TCB-1's non-volatile memory.

Exiting Level 2

Once you have finished editing the radio profiles changes you will need to exit. Exiting is accomplished by pressing and holding the adjuster knob until requested to release it. If the display requests a slot number to store the changes in, you must select from any of the fifteen user slots. If changes were made, the TCB-1 will write the changes to the internal Flash permanent memory. This process takes about 5 seconds when changes are written. If no changes have been made, you will be returned to Level 0.

Level 3

Level 3 is referred to as the Advanced Setup level. This level allows the user to access all aspects of the TCB-1. Only qualified persons should ever access this level.

How do I get in to Level 3?

Access to Level 3 is from the adjuster knob. From Level 0, the runtime level, the user should press and hold the adjuster until the LCD display shows "Release Adjuster for adv Settings". When this message appears, release the knob.

Is this level password protected?

When you release the adjuster knob, if the display prompts you for a 3 digit password then only the basic password requirement is enabled. In this case, you must enter the three digit password in order to access Level 3. If the display prompts you for a 6 digit password, then the advanced password requirement is enabled. In this case, you must enter the 6 digit password in order to have access to Level 3.

In general, the TCB-1 will require the most difficult password if both the basic and advanced password systems are enabled. If no password is entered within 30 seconds, the display will return to level 0. The password defaults off. You can change and enable the password under the system menu available from Level 3.

Selecting five menu editing menus

Once you have entered Level 3, you can select from five editing menus. These menus contain port specific and system wide settings. Care must be taken when adjusting certain parameters. A clear understanding of the variables should be taken before changing port and system wide settings. Refer to later parts in the manual for specifics on Level programming.

The Adjuster:

The adjuster is the device the TCB-1 uses to access the set-up and configuration menu's. It serves as the up and down selection control along with the <Enter> key. Rotate the knob left or right to select features, and press the knob to <Enter> the selection.

Special Case Knob function [Reset TCB-1 to factory settings]

There may be a need to completely wipe the internal storage and set all variables back to factory defaults. When this is done, all information is erased, including the customer entered radio personalities.

Factory Initialization Steps

1. Press and hold the Adjuster while applying power to the TCB-1
2. Continue holding until the LCD prompts you
3. Acknowledge either Yes or No to proceed and press the adjuster
4. If you acknowledge yes, a second acknowledgment is requested
5. Enter password (LCD displays as PWD) or contact Link Communications for a 1 time user password based on the 5 printed digits to the right of the LCD message.
6. Press the adjuster the second time and the initialization is done
7. All variables, including user entered radio profiles, are reset. Take care when re-initializing the interface. You may want to run the Graphical User Interface (GUI) which is available from the TCB-1 site, and get a download of your data flash before you execute a re-initialization sequence.

Special Case Knob function [Enter set-up mode from the operate mode]

Setting up the TCB-1 requires you to cycle between three levels of configuration.

- | | |
|---------|---|
| Level 1 | Select the radio personalities for a connected port |
| Level 2 | Edit and develop a custom radio personality |
| Level 3 | Port specific and system setup |

To enter set-up mode, press and hold the adjuster until the desired level is displayed. The LCD will prompt you to release the adjuster when complete.

Special Case Knob function [Exit set-up mode and save changes]

When you have completed editing the variables within one of the three levels, you need to exit and return to the run-time display (Level 0). This is accomplished by pressing and holding for 3 seconds. The display will prompt you to release the adjuster. If changes were made, the changes will be written to the non-volatile memory inside the TCB-1. Once the changes are stored, the TCB-1 will return to its normal display.

Level 1 Example

Level 1 is used to allow the user to assign radios to the TCB-1. In field application use, only assigning radios is typically used. No other features or functions can be adjusted from within the Level 1.

Set Radio1 Type?
Press ADJUSTER

Press Adjuster to proceed to the Radio Personality Screen

Slot[4]
Spectra

Dial the Adjuster and choose the Spectra
Radio

Confirm Recall?
Yes

Press Adjuster to accept selected radio type

Now you have selected the radio type for radio port 1, the Spectra. Once the adjuster has been pressed, the LCD takes you back to the Level 1 screen where you can select radio port 2's radio type. For this discussion, the radio selected for port 2 is the HT/MTX conventional radio.

Once you have selected the radios for both port 1 and port 2, you need to exit set-up. Press and hold the adjuster until the display tells you to release in order to exit. If any variables have been changed, the TCB will store the changes into Flash memory.

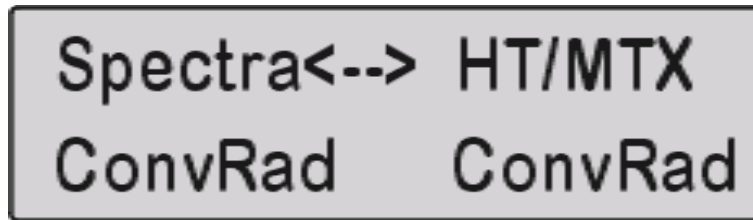

Spectra<--> HT/MTX
ConvRad ConvRad

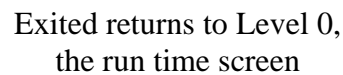

Exited returns to Level 0,
the run time screen

You TCB-1 will now operate, connecting the Spectra radio, located on port 1, to the HT/MTX, located on port 2. You can watch the front panel LED's to verify radio operation.

Refer to the flowcharts for information about the TCB-1's menu system

TCB-I Menu Flow

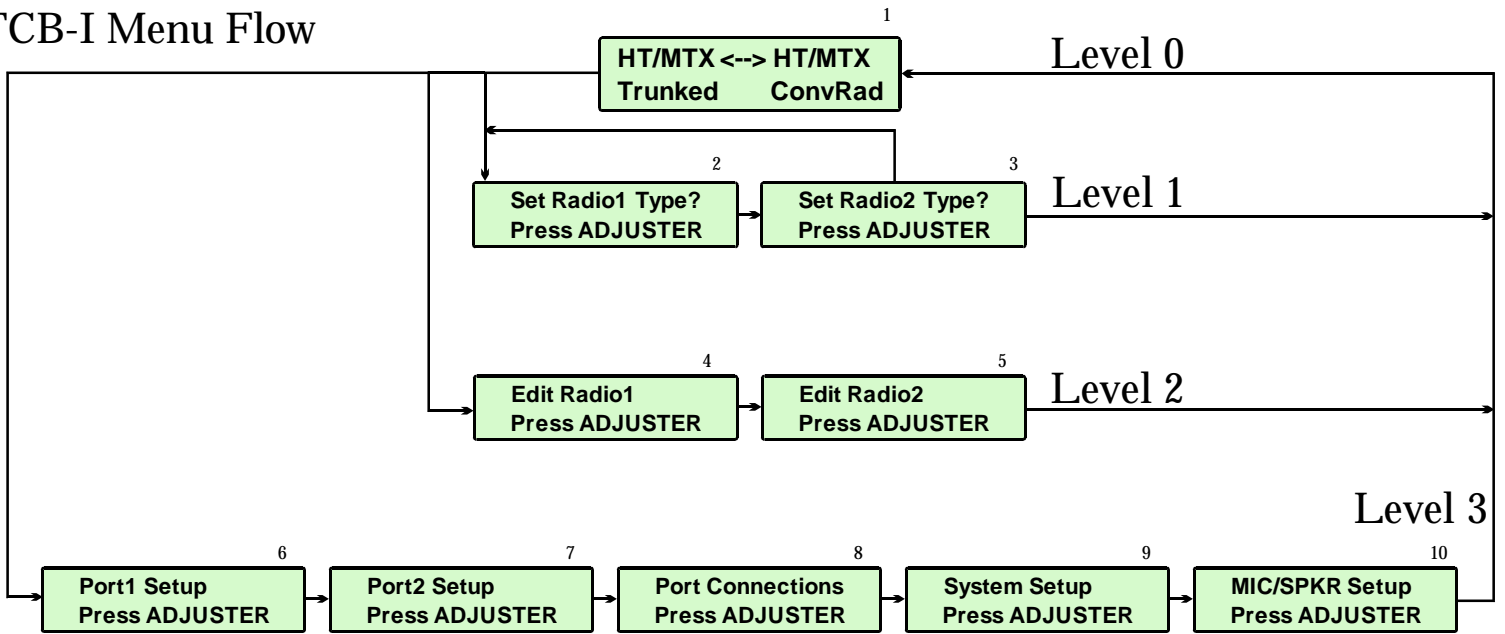

See Description Below For Each Menu

The small number next to the menu description identifies the menu number. The manual uses this number when describing the menus function.

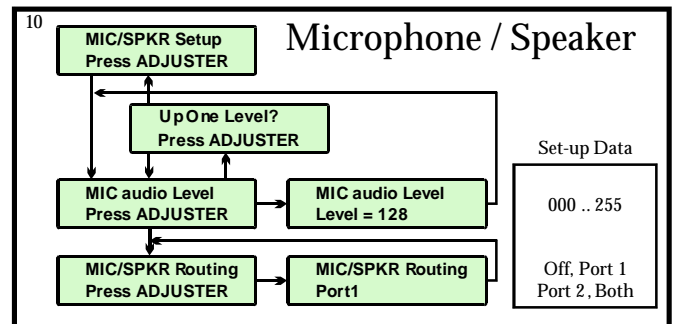
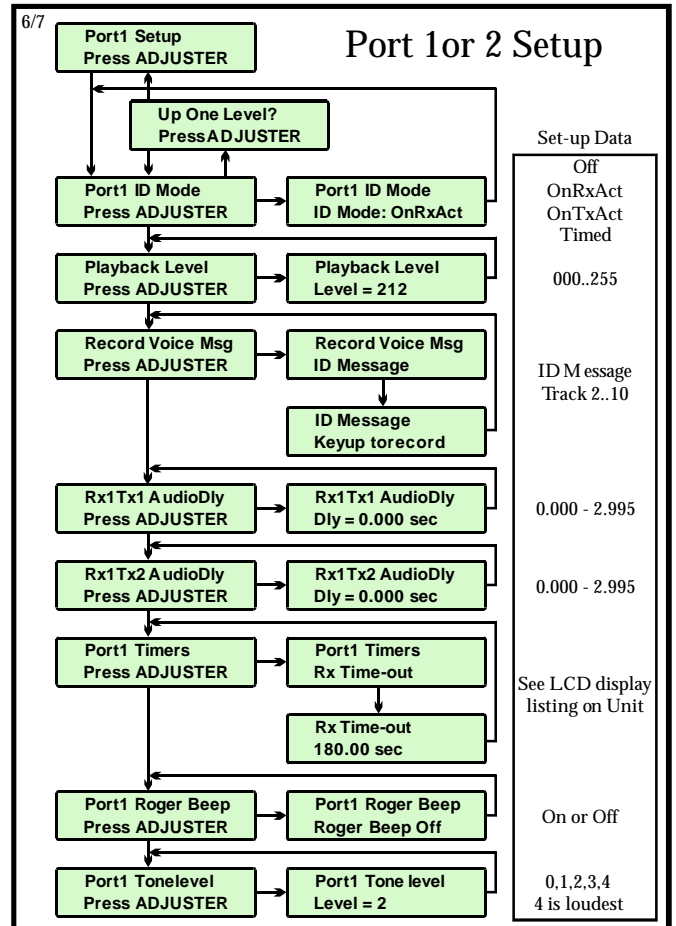
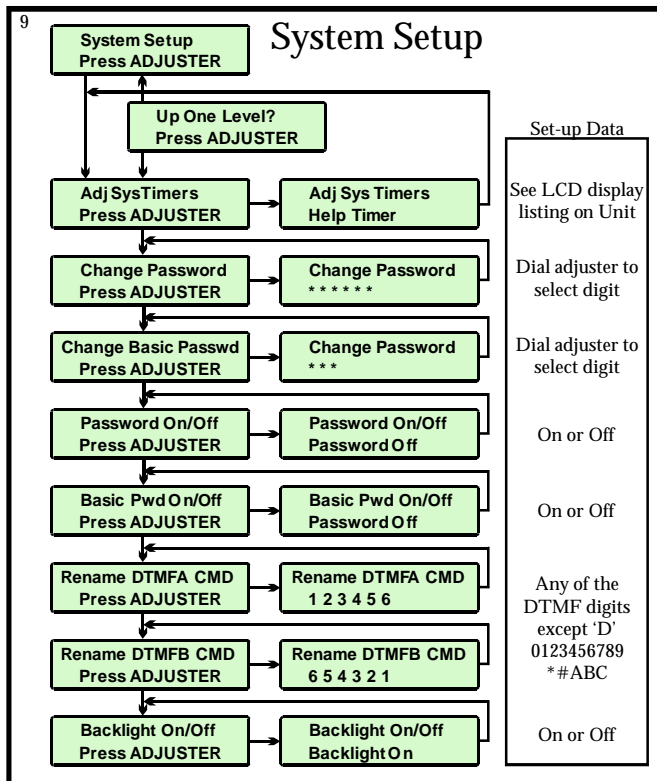
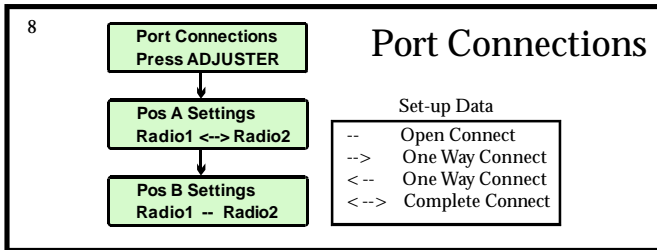

TCB-I Menu Flow Radio Profile Flow Chart

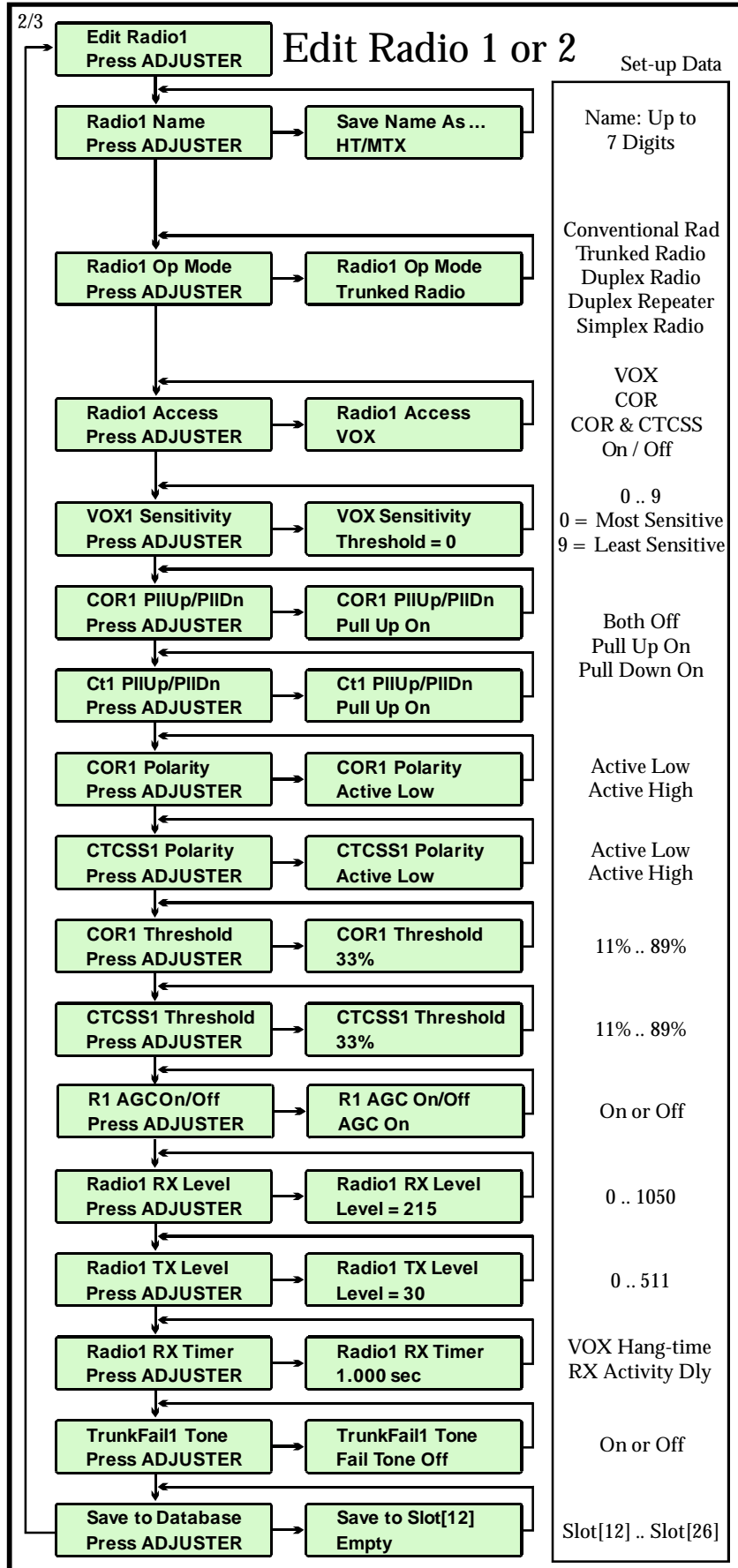

Menu Description

1

Runtime display prompt

This is the initial menu screen that is visible during runtime operation. The LCD displays the radios assigned to each port, the connection information along with the operational mode of each radio. From this display, you can verify that your TCB-1 is configured correctly for the radios attached.

2

Set Radio 1 Type?

Set Radio 1 type allows the user to select, from the programmed radio personalities, a specific radio to assign to this port. By pressing the Adjuster from this prompt takes the user to the radio selection menu. Once a radio is selected, the user can choose to exit and save the changes.

A password may be required to enter the basic setup mode. If enabled (See system setup , Menu selection 8 to enable/disable/change the Basic password), the user must enter the Basic password before entering this adjustment stage. The three letter Basic password defaults to (123).

3

Set Radio 2 Type?

Set Radio 2 type allows the user to select, from the programmed radio personalities, a specific radio to assign to this port. By pressing the Adjuster from this prompt takes the user to the radio selection menu. Once a radio is selected, the user can choose to exit and save the changes.

4, 5

Edit Radio 1 (Menu 4)

Edit Radio 2 (Menu 5)

The edit radio menu allows a user to edit and/or develop a Programmable Radio Profile (PRP). All variables that are associated with the radio's profile are editable from this menu.

Radio 1 Name:

The radio name is the name used to identify the radio profile. The name can be anything from 1 to 7 digits. You will want to use unique names depending on the radio's operation and function. For instance, an HT/MTX name identifies the radio connected, but does not identify the radio's operation mode. The name would be better described by naming it HT/MTXc for the conventional radio or HT/MTXt for the trunking version. Both radio's profiles are the same except the operating mode is different. The conventional radio has the Radio Op Mode field set as a Conventional Radio while the trunking Radio's Op Mode field is set as Trunking Radio.

Radio 1 Op Mode:

This field determines the operation mode for the connected radio. There are five operational modes that can be assigned to the radio. You will need different operational modes for the same radio, that operates as two different modes. The operating mode of the radio personality will be displayed on the LCD in during the normal operating condition.

Operational Modes:

Conventional Radio In this mode the radio operates as a simple transmitter and receiver. It forces half duplex operation (the receiver or transmitter can be active separately, but cannot be active at the same time)

Trunked Radio This mode is used when the radio is connecting to a trunked system. In this mode the TCB-1 enables the Adaptive Digital Audio Delay (A variable audio delay based on the Channel Available tone). When the radio is configured as trunked, the radio must generate some audible indication when the transmitter is first keyed (within three seconds), indicating it is ok to talk. The tone, typically called the channel available tone, tells the TCB-1 when to start playing the active receiver's audio. If no tone is generated, a trunk fail tone will be sent out the keying radio's transmitter when the receiver goes from active to inactive.

If your trunked radio does not generate a "Channel Available" tone, then set the Operating mode as Conventional Radio, not Trunked.

Duplex Radio This indicates the connected radio is a full-duplex radio. The radio is controlled like a conventional radio with the exception that it can operate full-duplex (both the receiver and transmitter can be active at the same time).

Duplex Repeater This indicates the connected radio is a full-duplex repeater. The TCB-1 will connect the ports received audio to the port's transmitter, when the receiver is active. It is a good idea to enable the hang timer and roger beep when configured for this mode.

Simplex Repeater This indicates that a half-duplex radio is connected, but that the voice store and forward feature is enabled. When the radio's receiver goes active, the TCB-1 will begin recording the receiver's incoming audio, up to two minutes. When the receiver goes inactive, the TCB-1 will key the radio's transmitter and begin playing back the recorded receiver audio. While the audio is being played back, a repeating beep will be injected over the played back audio (refer to menu 9, Port1 tone level to adjust the level of the

beep).

Simplex Repeater Continue

The tone is to signal the users that are monitoring the simplex repeater that the repeater is playing back a message. The main use of the simplex repeater is in emergency communications, where a repeater is needed but a duplex radio, duplexers are not available.

The simplex repeater mode is also helpful in the TCB-1's adjustment. Once the receiver level is adjusted correctly, the simplex repeater can be used to set the transmitter audio levels. Once the receiver is adjusted, generate a known level tone (Typically a 1 KHz tone deviated at 3 KHz) into the receiver. After about 30 seconds turn the tone off and monitor the transmitters audio out. Adjust the transmitter level to match the generated level. More on this topic later.

Radio Access Mode:

The radio access mode determines what method the TCB-1 uses when detecting the presence of the port's receiver. This is part of the radio personality because different radios have different signaling information. The default access mode for the built-in personalities is VOX (Voice Operated Access).

VOX	Voice Operated Access. This mode uses the DSP's voice presence detection mode for detecting receiver activity. When operating in this mode, the audio must be squelched, de-emphasized audio. If none is available, you will need to locate a receiver COR signal or install a RLC-MOT squelch module.
COR	Carrier Operated Receiver. This mode requires an external keying signal that indicates when the receiver is active or inactive. This signal is available on most mobile radio equipment, and provides the fastest and most reliable receiver indication signal. The COR signal can be programmed for its active level and threshold.
COR and CTCSS/DCS	This mode requires activity on both the COR line (pin 7 on the radio's DB-9 connector) and the CTCSS/DCS line (pin 2 on the radio's DB-9 connector). When both of these signals are active, the TCB-1 will consider the receiver to be active. If either of the signals goes inactive, the TCB-1 will consider the receiver to be inactive.
Always On	This mode turns On the receiver access always. This mode is mainly used for testing. <i>The TCB-1 will timeout the receiver if left in this mode</i>
Always Off	This mode turns Off the receiver access always. This mode is mainly used for testing.

VOX Sensitivity Adjustment:

This mode allows the sensitivity of the VOX detector to be adjusted. The default setting for this adjustment is 0, which is the most sensitive. If connecting to a repeater with a long hang-time tail, the “hiss” of the repeater hang time can keep the TCB-1's VOX active. Adjusting the VOX sensitivity will “deafen” the VOX circuit. Adjust the value until you achieve optimum performance. This adjustment ranges from 0..9.

COR 1 Pull Up / Pull Down:

This mode is only used when using the COR receiver detect line (pin 7 on the radio’s DB-9 connector). The function of this command is to turn on or off a weak pull-up or pull-down resistor. This is needed when your COR line goes from either an open to ground (pull-up needed), or a voltage to an open (pull-down needed). If your COR line is a logic signal, then this feature is not needed. The default setting is the weak pull-up resistor is enabled.

Both Off	; Neither a pull-up or pull-down is enabled
Pull-Up On	; Enables a weak pull-up resistor
Pull-Down On	; Enables a weak pull-down resistor

CT 1 Pull Up / Pull Down:

This mode is only used when using the CTCSS receiver detect line (pin 2 on the radio’s DB-9 connector). The function of this command is to turn on or off a weak pull-up or pull-down resistor. This is needed when your CTCSS line goes from either an open to ground (pull-up needed), or a voltage to an open (pull-down needed). If your CTCSS line is a logic signal, then this feature is not needed. The default setting is the weak pull-up resistor is enabled.

Both Off	; Neither a pull-up or pull-down is enabled
Pull-Up On	; Enables a weak pull-up resistor
Pull-Down On	; Enables a weak pull-down resistor

COR 1 Polarity:

This mode allows the COR active polarity to be assigned. If the COR goes from a low voltage to a high voltage when active (squellch open), the COR is said to be active high. If it goes from a high voltage to a low voltage or ground, the COR is said to be active low. The default polarity is active low.

Active Low	; Goes from a higher voltage to a lower voltage or ground when the line goes active
Active High	; Goes from a lower voltage to a higher voltage when active

CTCSS 1 Polarity:

This mode allows the CTCSS active polarity to be assigned. If the CTCSS goes from a low voltage to a high voltage when active, the CTCSS is said to be active high. If it goes from a high voltage to a low voltage or ground, the CTCSS is said to be active low. The default polarity is active low.

Active Low ; Goes from a higher voltage to a lower voltage or ground when the line goes active

Active High ; Goes from a lower voltage to a higher voltage when active

COR 1 Threshold:

This setting allows the user to adjust the voltage above which the COR signal is considered “high”. With some COR signals, the voltage change from inactive to active is relatively small. The DSP’s analog convertor allows you to set the threshold level from 11% to 89%. The ‘%’ is referenced to +5V internally. So 11% would indicate voltage of 0.550V. The default threshold is set to 33% or 1.65V.

CTCSS 1 Threshold:

This setting allows the user to adjust the voltage above which the CTCSS signal is considered “high”. With some CTCSS signals, the voltage change from inactive to active is relatively small. The DSP’s analog convertor allows you to set the threshold level from 11% to 89%. The ‘%’ is referenced to +5V internally. So 11% would indicate voltage of 0.550V. The default threshold is set to 33% or 1.65V.

Radio 1 Receiver AGC Control:

Because of the variety of radios that can be connected to the TCB-1, and the variability of the receiver volume levels presented during operation (handheld volume adjustments are not exact), the TCB-1 supports a DSP based automatic gain control (AGC). The AGC looks at the audio level and constantly adjusts the level. The result of the automatic adjustment is dynamic, full quality audio. If the connected radio has a constant audio output (pre-volume, non-discriminator audio), you may not need the AGC. The AGC will, however, adapt itself to a quiet speaking person, so you may want to keep the AGC enabled.

Radio 1 RX Level:

This menu item lets you adjust the receiver’s input level. The TCB-1 likes to see the level centered around 70% of max, where max is the point where the analog-digital convertor begins to clip. The process of adjusting the receiver level is to generate a 1 KHz tone, deviated to 3 KHz into your receiver. Adjust the TCB-1 until its meter reads 70%. If you do not have a service monitor, try to adjust the receiver so typical modulation is around 70%. If you are using the automatic gain control (AGC), then the 70% level is what the AGC tries to center itself around. Once you set the level, note the setting of the volume control knob (if using speaker audio). This is the point at which you set your volume knob when using this radio personality.

Radio 1 TX Level:

This menu item lets you adjust the transmitter’s audio level. The TCB-1 can be adjusted from 0 to 511. The large adjustment range is required because of the large range of transmit audio levels required by various radio’s. Handheld levels are around 30 and mobile radios are around 300. The method of setting the radio’s transmit level requires use of the Simplex Repeater

operating mode. Once the receiver level is adjusted correctly, the Simplex Repeater operating mode is used to set the transmitter audio levels. Once the receiver is adjusted, generate a known level tone (Typically a 1 KHz tone deviated at 3 KHz) into the receiver. After about 30 seconds turn the tone off and monitor the transmitter's audio out. Because the port is set in the Simplex Repeater mode, once the receiver goes inactive, the TCB-1 will begin playing back the recorded tone standard. Once the playback begins, adjust the transmitter level to match the generated level.

If you do wish to go through this process to setup the TCB-1's transmitter audio level, you may want to either select the default handheld or default mobile personality as a good starting point.

Under Radio1 Timers .. Radio 1 VOX Hang-Timer:

This timer determines how long the TCB-1's VOX will remain active when voice is not detected. All voice has peaks and pauses. Without a VOX hang-timer, the VOX would go inactive when the pauses were detected. The VOX hang-time smooths the peaks and pauses for a smooth detection. This timer defaults to 0.750 seconds. If you notice the VOX detector going inactive when people talk, lengthen this timer.

Note: The timer will hold the VOX active for the length of the timer from the time the last voice was detected. Having this timer too long could slow the communication hand-off. Some experimentation may be needed to optimize performance.

Under Radio1 Timers .. Radio 1 Rx Activity Delay Timer:

This special timer is used to block information that comes from some radios when they go from transmit into receive. Some devices send a Transmit un-key beep. If your TCB-1 is configured for VOX receiver access mode, this beep can be a problem. The beep can cause the TCB-1 to incorrectly detect receiver activity, thus causing a PTT on the opposing radio port. This in turn can cause the other radio to generate the same beep, which causes the other radio port to PTT, and so on. This condition, called "ping-ponging" can cause problems when connecting two systems together. This timer could also be called the Receiver Anti-Activity timer. This timer will cause the TCB-1 to ignore receiver input from a radio that just went from transmit to receive. The timer defaults to 1.0 second. It is important not to set this timer too long as you could cause information to be missed.

This timer is also helpful when a radio causes a squelch burst when going from transmit to receive. The squelch burst can cause the same ping-ponging effect.

Typically you will not need to set this timer for more than 1.5 seconds. It is a good idea to turn off all the beeps that your radio generates, except the ones needed (Trunking mode operates best when a Channel Available tone is generated).

Save to Database:

After setting up a radio, you should save your settings (so they will be restored after cycling power) by holding the adjuster in for several seconds (until the “Release Adjuster” message appears on the LCD).

Exiting will force the changes to be saved in one of the 15 user slots. If no changes were m

If you wish to save setup information for several different radios (so you can switch between them easily), you may want to setup a “personality” for each one.

The TCB-1 ships with personalities for several common radios. These cannot be changed. You can, however, load one of them (see “Basic Setup” near the beginning of the manual), make changes and save the result to the “Radio Database” as a new entry. It will then be available from Basic setup in the future.

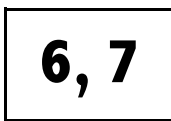

Port 1 Setup (Menu 6)

Port 2 Setup (Menu 7)

Port 1 setup is comprised of several menu setup options. General port specific functions are accessed here. Nothing to do with the Radio Personalities is setup here. See Edit Radio 1 for personality specific settings.

Port 1 ID Mode:

The TCB-1 supports the ability to send a port specific identification. The ID is sent as a Digital Voice Recorded message. There are four options for how to trigger the ID message.

The four options are:

- Off ; Identification system for port 1 disabled
- OnRxAct ; Identification triggered from receiver activity
- OnTxAct ; Identification triggered from transmitter activity
- Timed ; Identification will beacon based on the ID timer only

Playback Level:

When using the TCB-1's simplex repeater mode (See Menu 2/3, Radio1 Op Mode), receiver audio is recorded to the internal Digital Voice Recorder. When this audio is played back, its level may need to be adjusted up or down. The level can be adjusted from 000 to 255, and defaults to 212. You should not need to adjust the recorder playback level. It is only used during the Simplex repeater operation and to play back ID's, if enabled.

Record Voice Msg:

When using the Digital Voice Recorder's internal messages, you need a way to record these messages. This command allows these messages to be recorded.

ID Message;	This message is used for Identification
Track 2 .. 10;	These message slots are reserved for future use

Once you select the message you want to record, the LCD display will prompt you with recording instructions. The audio input source for recording is the front panel microphone. When prompted to key-up to record, press the microphone push-to-talk (PTT) and begin speaking. The message slots are 10 seconds in length maximum. Once you un-key the microphone, the TCB-1 will play the message back, out the local speaker. If you do not like the recording, reselect the message and do it again.

RX1TX1 Audio Delay:

The TCB-1 supports a user adjustable digital audio delay. The audio delay can be tailored to your specific application. The RX1TX1 delay is only used when the port is configured as a Duplex Repeater (See Menu 10, option Radio1 Op Mode). If this is not your configuration, then set this timer to 0.000 seconds. There is a total 2.995 seconds of digital audio delay memory available for the complete TCB-1. If you do not need the delay on this port, then set the value to 0.000 seconds to free up delay memory on the other port.

This value is adjusted in 0.1 second increments, from 0.000 to 2.995 seconds
This value defaults to 0.000 seconds

RX1TX2 Audio Delay:

The TCB-1 supports a user adjustable digital audio delay. The RX1TX2 delay is used when cross connecting radio ports. A good application for this delay is to delay Port 1's receiver when accessing a repeater with DCS access. Such repeaters typically require approximately 200mS for the DCS to be decoded. If you set the TCB-1's audio delay to 0.200 seconds, the PTT will happen non-delayed, and the audio will be sent 200mS later. This ensures that no audio information will be lost when talking through the repeater.

If Port 2 is configured as a Trunked radio, the TCB-1 will delay up to 2.995 seconds while it waits for Port 2's "Channel Available" beep to go away. Then the TCB-1 will begin to play Port 1's receiver audio back. This method, described as Adaptive Audio Delay, will provide a variable audio delay controlled by the "Channel Available" tone. If you do not need the audio delay on this port, then set the value to 0.000 seconds to free up delay memory on the other port.

(For additional information on the Trunking Audio Delay, refer to the application notes at the end of the manual)

This value is adjusted in 0.1 second increments, from 0.000 to 2.995 seconds
This value defaults to 0.000 seconds

Port 1 Timers:

There are several timers which influence how each port operates. There are several other listed timer. You should only need to adjust the listed ones.

Timers:

Rx Time-Out	This timer determines the maximum length the receiver can be active. If the timer expires, the TCB-1 will ignore the receiver activity until it goes from the active state to the inactive state
PTT Time-Out	This timer determines the maximum length the transmitter can be active. If the timer expires, the TCB-1 will turn off the transmitter until it goes from the active state to the inactive state
PTT Hang-Time	This timer holds the transmitter active for a while after the keying source goes away. It helps smooth out the PTT "bumps" on the transmitter
VOX Hang-Time	Time timer holds the receiver active indication during short pauses that occur with speech. If this timer is set too short, the TCB-1 may perceive an unkey when one has not happened
Roger BeepDly	This timer delays a small amount before starting the Roger beep. This allows other traffic to acquire the receiver before the beep is sent
ID Time	This timer determines how often an identification message is sent. If the ID mode is configured as timer, this becomes the beacon timer for the ID message
ID Hold Off	This timer is started when an identification message is required, but there is activity on the receiver. This allows the ID to act polite and not interrupt the receive activity with an ID. But if this timer expires and the receiver is still active, an identification message will be sent regardless of the receiver activity

The timers default to the following times:

Rx Time-Out	; 600 seconds or 10 minutes
PTT Time-Out	; 600 seconds or 10 minutes
PTT Hang-Time	; 0.01 seconds
VOX Hang-Time	; 750mS or 0.750 seconds
Roger BeepDly	; 0.00 seconds
ID Time	; 1800 seconds or 30 minutes
ID Hold Off	; 20 seconds

Port 1 Roger Beep:

The roger beep (also called courtesy beep) is a tone that is sent when the receiver goes from active to inactive. This is used to signal that it is ok for another party to talk. The user can either turn the beep on or off. The default condition of this state is Off.

Port 1 Tone Level:

The tone level control allows the user to set the volume of any tone events. The tone level can be adjusted from 0 to 4, where 0 is off and 4 is maximum tone level. The default setting is 2.

The tone events are:

Roger Beep	; Triggered by receiver activity
Simplex cover tone	; This tone is sent while the recorded voice is playing from the internal Digital Voice Recorder.
Trunk Fail Indicate	; This tone is sent when an error occurs when linking to a trunked radio. The condition that trigger this tone is the channel access tone was longer than 3 seconds and information might have been lost when transmitting on the trunked radio.

8

Port Connections (Mode A and Mode B Settings)

The TCB-1 supports two user operational modes. These user modes are configured from Menu 8's prompt.

Pos A Settings indicate how the TCB-1 will operate when the front panel switch is set to the 'A' position. This mode defaults to '<- ->' indicating both Port A and Port B are connected

Pos B Settings indicate how the TCB-1 will operate when the front panel switch is set to the 'B' position. This mode defaults to '- -' indicating that Port A and Port B are disconnected

You are given four possible settings for Position A and Position B. These settings control only the radio port's connection modes.

- <- -> Indicates that Port A and Port B are connected
- -> Indicates that Port A causes a transmit on Port B only
- < - - Indicates that Port B causes a transmit on Port A only
- - Indicates that each port operates independently

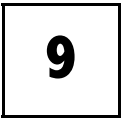

System Setup

The TCB-1's system menu is for settings that are not specific to the radio port's operation. Password, backlight control and DTMF command name assignment features are configured here.

Adjust System Timers:

These timers control several internal features of the TCB-1. Changes should only be made when instructed by Link Communications technical support.

Change Advanced Password:

The TCB-1 allows the user to assign a six digit password to the Advanced setup option. This allows control on who can access the TCB-1's advanced setup menus.

The Advanced password defaults to **1 2 3 4 5 6**

Password names can be any of the digits the TCB-1 supports.

Change Basic Password:

The TCB-1 allows the user to assign a three digit password to the Basic setup option. This allows control on who can access the TCB-1's Basic setup menu.

The Basic password defaults to **1 2 3**

Password names can be any of the digits the TCB-1 supports.

Advanced Password On/Off:

The TCB-1's Advanced password can be enabled or disabled. When enabled, the user must enter the password before accessing the Advanced setup menu or re-initialization of the TCB-1. The password defaults Off.

Basic Password On/Off:

The TCB-1's Basic password can be enabled or disabled. When enabled, the user must enter the password before accessing the Basic setup menu. The password defaults Off.

Backlight On/Off:

The TCB-1's LCD supports a backlight for night viewing of the LCD display. The LCD display draws more DC current when the light is on. So if you need lower DC current, set the backlight control to the Off position. The backlight defaults to the 'On' position.

DTMF Command Name Assign:

The TCB-1 supports the ability to switch the units Mode 'A' or Mode 'B' switch using DTMF tones. The command can be sent from either radio port, and are 6 digits in length.

The Mode 'A' command name defaults to '123456'

The Mode 'B' command name defaults to '654321'

When entering DTMF Mode 'A' command, a 2 second long 1 KHz tone will be sent. No response will be sent if the DTMF command name is incorrect.

When entering DTMF Mode 'B' command, a 2 second long 500 Hz tone will be sent. No response will be sent if the DTMF command name is incorrect.

10***Microphone and Speaker Setup***

The front panel microphone can be set to transmit and receive from Port 1 and/or Port 2. This allows the front panel microphone and speaker to be an operator's console interface, without requiring a radio. Because of the differences between microphones that can be used, there is a level adjustment to match the microphone to the TCB-1's input. The TCB also provides the needed power to operate DTMF generation microphones.

MIC audio Level

This adjustment sets the microphone level to best match the TCB-1's input circuits. This setting can be adjusted between 0 and 255. The default setting is 128, or mid scale.

MIC/SPKR Routing

This adjustment allows the microphone to be routed to Port 1, Port 2, Both or None. The default setting is routing to Port 1 only. The speaker follows the microphone routing.

Radio Port Configuration Settings

The RJ-45 connector used for a radio interface can be configured to handle most interface applications. The factory default settings configure the radio port to handle the TCB's pre-fabricated radio cables. It is important to fully understand your interfacing requirements before changing the setting of the configuration switches. Incorrect switch settings can affect the operation of the interfaced radio. The switches are located on the rear of the TCB-1.

All ports are shipped with settings for the Pre-Fabricated Radio Cables

Switch Definitions

Switches 1,2,3 are designed for configuring your radio's PTT requirement. Your radio's PTT requirement will determine the settings of these switches.

Switch 1: Connect PTT to the Audio Output Lo side of the transformer (Default)

On radios that do not have a dedicated PTT, a lo-side transformer configuration is required. In this configuration, the radios PTT is carried through the microphone audio line. When the radio needs a PTT, the PTT signal pulls the transmit audio to a lower resistance and the radio transmits.

Switch 2: Connect PTT to TCB-1's ground

On radios where there is a dedicated PTT input (Mainly Mobile Radios), a PTT reference to ground is needed. When a PTT condition is needed, the PTT signal will be grounded when in transmit, and will be open in receive.

Switch 3: Connect PTT to the External Reference pin

On radios where a keying voltage is required, or system isolation is needed, the PTT would be set-up to use the external reference pin. This pin (RJ-45 pin 5), is available to allow custom keying reference configurations. When connecting Intrinsically safe radios, to the TCB-1, no unit grounding is allowed. In this example, the user would turn switch 3 ON and connect the radio's ground (which is different from the TCB's ground) to the PTT signal. When the TCB required a PTT condition, the PTT would present the radios externally isolated ground to the radio for causing a PTT to occur.

Note:

When Switch 2 and Switch 3 are both ON, the RJ-45's pin5 (External Reference) is connected to the TCB-1's ground reference. This allows a common ground to be available for external devices. When utilizing this ground, your external ground should be connected to pin 5 located on the RJ-45 connector. **DO NOT HAVE SWITCHES 4 AND 5 BOTH 'ON' IN THIS CONFIGURATION.** It will connect +Vinput (12V) to ground, causing the cards output limiting fuse to open.

Switches 4,5 control what source powers the opto-isolators used for external COR and CTCSS detection. In the default position, the TCB-1 powers the anode of the opto-isolator, allowing an external ground to indicate that either the COR/CTCSS pin is active. When configuring the TCB for intrinsically safe operation, and where an external COR/CTCSS signal is required, the switch would be configured to use the external reference pin.

Switch 4: Connect the Optical Isolated Anode line to the TCB's +Vinput (Default)

This switch determines if the COR/CTCSS opto-isolators on the TCB's radio cards are powered from the TCB's power supply or an external reference. When "ON", the opto-isolators use the +Vinput that powers the TCB-1. This is a non-isolated condition.

Switch 5: Connect the Optical Isolated Anode line to the External Reference pin

This switch determines if the COR/CTCSS opto-isolators on the TCB's radio cards are powered from the External Reference line (RJ-45 pin 5). When "ON", the opto-isolators use the External Reference line to power the opti-isolators. The opto-isolator and handle voltage up to +48V DC. A ground on either the COR or CTCSS line will cause the opto-isolator to turn on, thus providing a valid COR/CTCSS condition.

Switches 6, 7, 10 control what type of receiver audio is required. The default audio input is balanced, 2-wire input. The load the radio will see in balanced mode is 600Ω. When a higher input load is required, and isolated input is not required, then un-balanced receiver audio is selected. The receiver load, in unbalanced configuration, is 47KΩ.

When connecting a radio's speaker to the audio input, balanced mode is required. Most of the handheld radios utilize "above ground" driving to power the speaker. If balanced audio is selected, the user would then connect the Audio-In Hi (pin 8) and the Audio-In Lo (pin 7) to the speaker +/- wires of the radio. This connection will ensure isolation from the radio's ground. It is important to know what your radio requires on the speaker interface. You can damage the radio's audio circuits if you connect the audio incorrectly.

Balanced Audio Input: Switches 6,10-On, Switch 7-Off (Default)

Un-Balanced Audio Input: Switches 6,10-Off, Switch 7-On

Switches 8, 9 control what type of transmitter audio is required. The default audio output is balanced, 2-wire output. The load the radio will see in balanced mode is 600Ω. When a single wire output is required, and isolated input is not required, then un-balanced transmitter audio is selected. The transmitter load, in unbalanced configuration, is 600Ω.

Balanced Audio Output: Switch 8-On, Switch 9-Off (Default)

Un-Balanced Audio Output: Switch 8-Off, Switch 9-On

Switch ON/OFF definition

When a switch is referred to being "On", the little tab on the switch is slid to the "On" indicator. Make sure when changing the position of a switch, that the switch tab is firmly









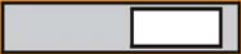

slid to the position required.

Switch configuration reference

On the back of each of the Dual Radio Module, there is a table referenced “Switch Settings” that outlines the definition of each switch. Only change the 10 position switch when configuring the audio. The 8 position switch on the back of the board is for configuring the RS-232 ports which will be covered later.

TCB's Pre-fabricated radio cables (Factory Default Setting)

The default setting of the TCB-1's radio port supports the TCB's pre-fabricated radio cables. Typically the switch settings do not need to be changed. In certain applications, the switch settings will need to be changed.

1		On	Switch 1: (On) PTT connected to the Lo-side of the Transmit Audio
2		On	Switch 2: (Off)
3		On	Switch 3: (Off)
4		On	Switch 4: (On) Opto-Isolator Anode connected to TCB +Vinput
5		On	Switch 5: (Off)
6		On	Switch 6: (On) Balanced Receiver Audio Selected
7		On	Switch 7: (Off)
8		On	Switch 8: (On) Balanced Transmit Audio Selected
9		On	Switch 9: (Off)
10		On	Switch 10: (On) Balanced Receiver Audio Selected

RJ-45 Pin-Out for this configuration

- Pin 1 - (CAT 5: White/Orange) PTT Output - Connectes to Audio Output Lo on Transmit
- Pin 2 - (CAT 5: Orange) COR Input - Configures the TCB-1 that the Receiver is active
- Pin 3 - (CAT 5: White/Green) CTCSS Input - Configures the TCB-1 that a CTCSS is active
- Pin 4 - (CAT 5: Blue) Audio Output Lo - Connected to the PTT signal
- Pin 5 - (CAT 5: White/Blue) External Reference Input - Not Used
- Pin 6 - (CAT 5: Green) Audio Output Hi - Connects the radio microphone input connector
- Pin 7 - (CAT 5: White/Brown) Audio Input Lo - Connects the radio's speaker Lo pin
- Pin 8 - (CAT 5: Brown) Audio Input Hi - Connects the radio's speaker Hi pin

TCB's Balanced In/Out w/E&M contact closure Signaling

When connecting the TCB-1 to a balanced radio system, where COR and CTCSS signaling is available, it is necessary to change switch settings along with changing port set-up features under the port set-up menu (LCD Screen Menu).

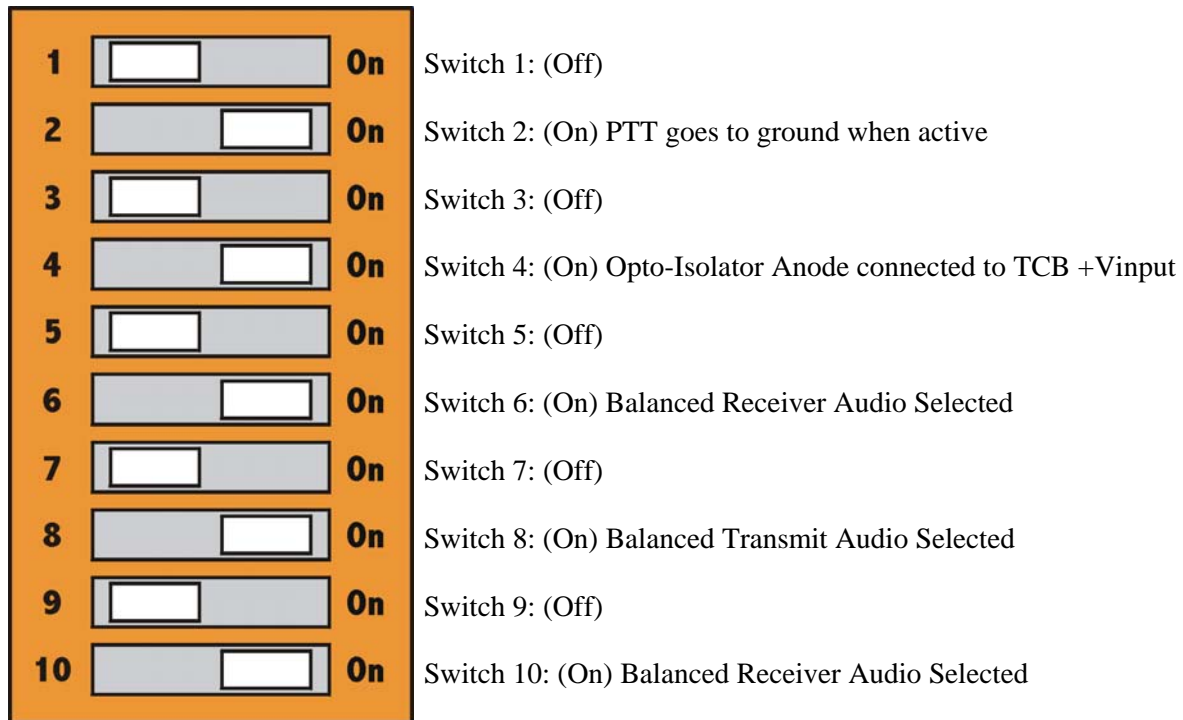

RJ-45 Pin-Out for this configuration

- Pin 1 - (CAT 5: White/Orange) PTT Output - Connect to M-Lead. Goes to ground on Transmit
- Pin 2 - (CAT 5: Orange) COR Input - Connect to E-Lead. Low when Receiver is active
- Pin 3 - (CAT 5: White/Green) CTCSS Input - Not Used
- Pin 4 - (CAT 5: Blue) Audio Output Lo - Connected to Balanced Audio Input Lo
- Pin 5 - (CAT 5: White/Blue) External Reference Input - Not Used
- Pin 6 - (CAT 5: Green) Audio Output Hi - Connected to Balanced Audio Input Hi
- Pin 7 - (CAT 5: White/Brown) Audio Input Lo - Connect to Audio Output Lo
- Pin 8 - (CAT 5: Brown) Audio Input Hi - Connect to Audio Output Hi

E&M Type 2/3, 4 Wire Interface

When connecting the TCB-1 to a VOIP or similar router that requires an E&M Type 2 or Type 3 interface, balanced and opto-isolated inputs are required. The TCB-1's flexible interface configuration supports this common format.

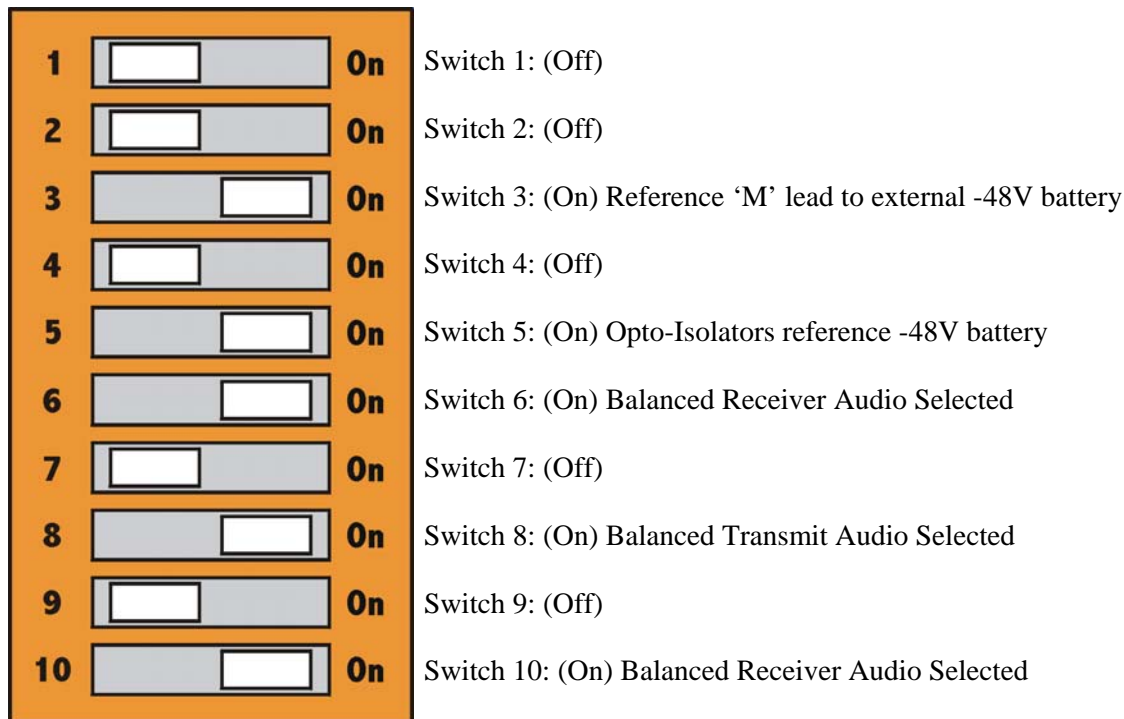

RJ-45 Pin-Out for this configuration

- Pin 1 - (CAT 5: White/Orange) M lead Output - Connect to M lead, pin 2 (Orange)
- Pin 2 - (CAT 5: Orange) E lead Input - Connect to E lead, pin 7 (White/Brown)
- Pin 3 - (CAT 5: White/Green) CTCSS Input - Not Used
- Pin 4 - (CAT 5: Blue) Audio Output Lo - Connect to Ring Audio Output, pin 3 (White/Green)
- Pin 5 - (CAT 5: White/Blue) External Reference - Connect to -48V battery, pin 1 (White/Orange)
- Pin 6 - (CAT 5: Green) Audio Output Hi - Connect to Ring1 Audio Output, pin 4 (Blue)
- Pin 7 - (CAT 5: White/Brown) Audio Input Lo - Connect to Tip Audio Input, pin 6 (Green)
- Pin 8 - (CAT 5: Brown) Audio Input Hi - Connect to Tip1 Audio Input, pin 5 (White/Blue)

Un-Balanced Audio In/Out with COR/CTCSS signaling

When connecting the TCB-1 to a mobile radio, or repeater set-up, non-balanced audio and COR/CTCSS signaling is typically required. In this mode, the COR and CTCSS will connect to the opto-isolators and there will be a reference ground. The Ground reference is available on Pin 5. It is very important to verify that Switch 5 is off. If the switch is incorrectly in the ON position, +Vinput and Ground will be connected causing the resettable fuse on the radio card to blow.

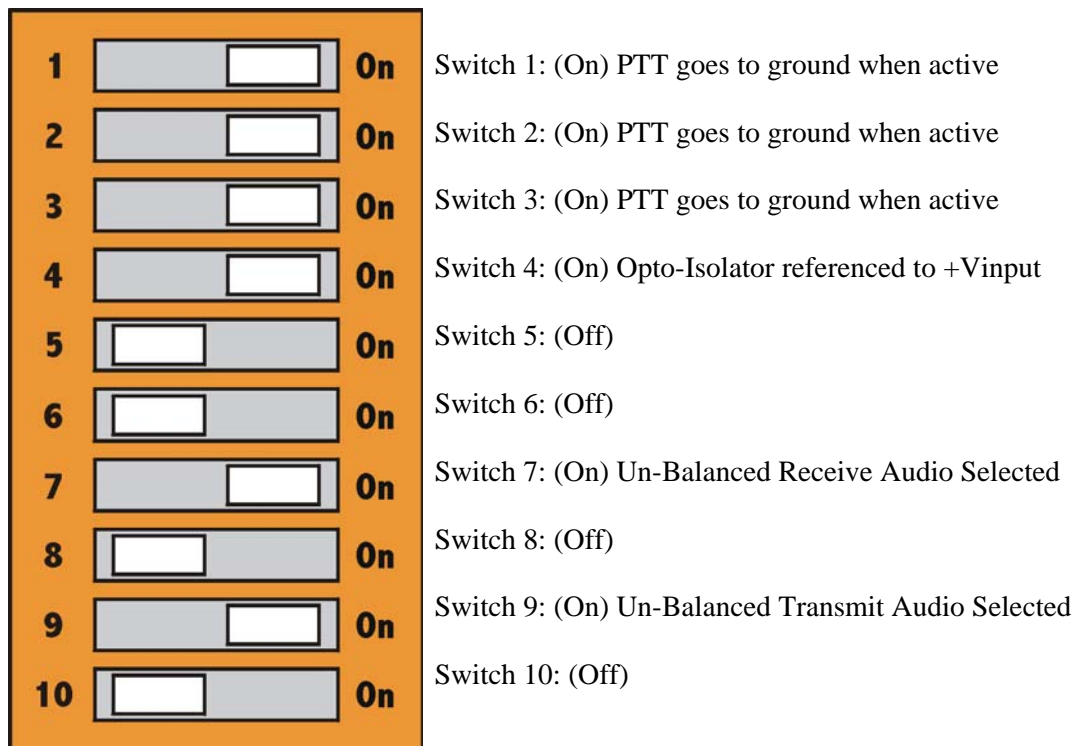

RJ-45 Pin-Out for this configuration

- Pin 1 - (CAT 5: White/Orange) PTT Output - PTT signal goes to ground on Transmit
- Pin 2 - (CAT 5: Orange) COR Input - Active Low COR (Can be inverted in set-up)
- Pin 3 - (CAT 5: White/Green) CTCSS Input - Active Low CTCSS (Can be inverted in set-up)
- Pin 4 - (CAT 5: Blue) Audio Output Lo - Not Connected
- Pin 5 - (CAT 5: White/Blue) External Reference - Connector to your Radio Ground
- Pin 6 - (CAT 5: Green) Audio Output Hi - Connect to Transmit Audio Input
- Pin 7 - (CAT 5: White/Brown) Audio Input Lo - Not Connected
- Pin 8 - (CAT 5: Brown) Audio Input Hi - Connect to Receiver Audio Output

E&M Type 3 Signaling





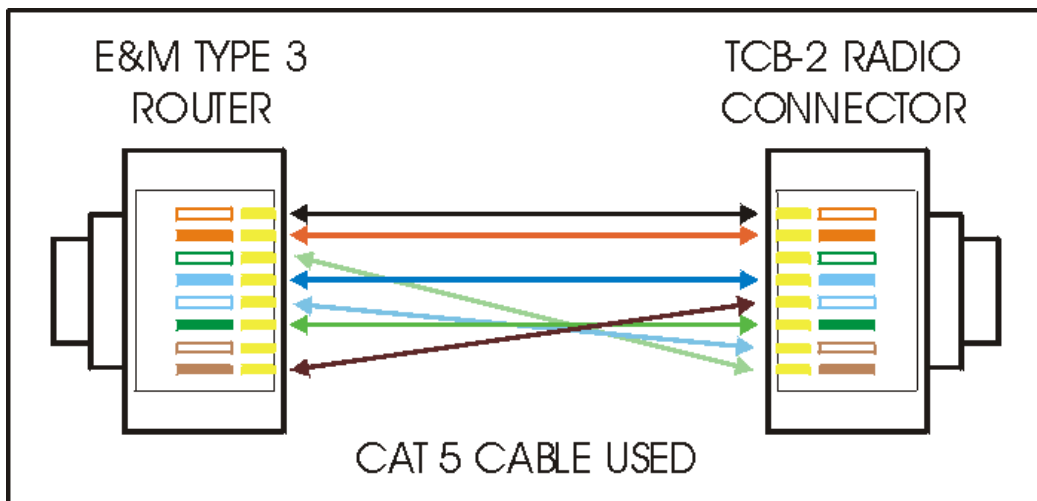





The TCB-1 cable wiring discussed will connect to an E&M Type 3 router to the TCB-1's radio connector port. E&M is a handshaking process between two PBX's or VOIP routers. The 'E' stands for Ear circuit (Speaker) and the 'M' stands for Mouth circuit. (Microphone). For our discussion, 4 wire E&M circuits will be used. When connecting the TCB-1 to an E&M interfaced router, a special cable will need to be fabricated. Link offers these cables for sale or you can follow the table below to build your own.

E&M Router	E&M Router RJ-45	TCB-2 Bridge	TCB-2 Bridge RJ-45
M Lead Input	White / Orange	PTT Output	White / Orange
E Lead Output	Orange	COR Input	Orange
T1 Audio Output	White / Green	Audio Input 1	Brown
R Audio Input	Blue	Audio Output 1	Blue
T Audio Output	White Blue	Audio Input 2	White / Brown
R1 Audio Input	Green	Audio Output 2	Green
Ground	White / Brown	Not Used	-----
Battery (-48V)	Brown	External Ref	White / Blue



Wiring chart using CAT-5 cable

When connecting the TCB-1 to a VOIP or similar router that requires an E&M Type 2 or Type 3 interface, balanced and opto-isolated inputs are required. The TCB-1's flexible interface configuration supports this common format.

1		0n	Switch 1: (Off)
2		0n	Switch 2: (Off)
3		0n	Switch 3: (On) Reference 'M' lead to external -48V battery
4		0n	Switch 4: (Off)
5		0n	Switch 5: (On) Opto-Isolators reference -48V battery
6		0n	Switch 6: (On) Balanced Receiver Audio Selected
7		0n	Switch 7: (Off)
8		0n	Switch 8: (On) Balanced Transmit Audio Selected
9		0n	Switch 9: (Off)
10		0n	Switch 10: (On) Balanced Receiver Audio Selected

RS-232 Serial Port

The RS-232 serial port on the Digital Processing Module allows the user to monitor and control operation of the TCB-1. This port is also used with computer GUI interface software for remote control of the interface.

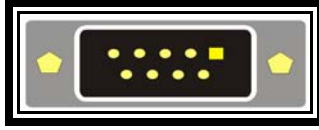

RS-232 Serial Connector

The default parameters for this connector are as follows:

Baud Rate: 115.2 K Baud
Start Bit: None
Data Bits: 8
Stop Bits: 1
Flow Control: Software

The pin-out for this connector:

Pin 1 - Tied to pin 4,6
Pin 2 - Serial Data Output from the TCB-1
Pin 3 - Serial Data Input to the TCB-1
Pin 4 - Tied to pin 1,6
Pin 5 - TCB-1 chassis ground
Pin 6 - Tied to pin 1,4
Pin 7 - CTS (Clear to Send)
Pin 8 - RTS (Ready to Send)
Pin 9 - Not Connected

The End